



NOVAMOBILI

Dedalo



Dedalo è infinita libertà progettuale. Un sistema a montanti versatile e ingegnoso, pensato per adattarsi con fluidità a ogni ambiente: dal living alla zona notte, fino allo spazio ufficio. La struttura portante combina montanti con attacco a parete o a soffitto e ripiani in vetro fumé, cuoio, light stone, essenza e laccato, incorniciati da un telaio in alluminio. A questi elementi si possono aggiungere contenitori, cassettiere e altri accessori, per progettare cabine armadio, librerie divisorie o pareti attrezzate, con ampia possibilità di personalizzazione nelle combinazioni e nelle finiture. I moduli di Dedalo, con larghezze variabili offrono anche la possibilità di progettare composizioni bifacciali, finite su entrambi i lati.

Dedalo equals endless design freedom. Our new Dedalo system, a clever and versatile combination of uprights designed to fit seamlessly into any interior: from the living area to the bedroom, and even offices spaces. The load-bearing structure uses wall-or ceiling-mounted uprights paired with shelves in smoked glass, leather, light stone, wood finishes and lacquered options set in an aluminium frame. These elements can be complemented with storage units, drawer units and other accessories to design walk-in wardrobes, room-dividing bookcases or whole storage walls, offering plenty of scope for customizing with different combinations and finishes. With Dedalo modules, with variable widths you also have the option of designing double-sided configurations, finished on both sides.

Dettagli prodotto	<i>Product details</i>	3
Ambienti casa	<i>Home spaces</i>	17
Info tecniche	<i>Technical data</i>	57

NOVAMOBILI

Dedalo



DEDALO SYSTEM

Dettagli prodotto

Product details

Ripiani e contenitori, disponibili anche con cassetti, si agganciano ai montanti attraverso una scanalatura centrale, garantendo una solida e stabile integrazione. Il profilo curvo degli elementi è un dettaglio raffinato che evidenzia la cura artigianale. I montanti possono essere integrati con una fonte di illuminazione LED, parziale o totale, che consente di illuminare ripiani e cassettiere, aggiungendo funzionalità senza compromettere l'estetica del sistema.

Shelves and storage units, which also come with drawers, attach to the uprights by means of a central groove, ensuring the resulting combination is solid and stable. The elements' curved edge is a refined detail that gives a handcrafted look. The uprights can incorporate a partial or full-height LED light source to illuminate the shelves and drawer units, adding functionality without compromising the system's aesthetics.





Ripiani e contenitori possono essere configurati con diverse altezze, permettendo una personalizzazione completa delle soluzioni. Dedalo offre inoltre la possibilità di fissare ai montanti un pratico tubo appendiabiti ed un porta TV con staffa orientabile per il televisore.

Shelves and storage units can be configured with different heights, allowing you to fully tailor solutions to individual requirements. With Dedalo, you also have the option of attaching a practical hanging rail to the upright as well as an accessory with a swivel mounting bracket for the TV.



Le ante a telaio con vetro fumé sono una soluzione raffinata per i contenitori: mantengono l'integrità visiva del sistema adattandosi ai diversi stili di arredamento. I contenitori possono essere ulteriormente completati dall'illuminazione LED, posizionata all'interno o all'esterno sotto il piano inferiore.

The smoked glass framed doors make for a refined storage solution: they maintain the system's visual integrity, blending with a range of decor styles. LED lighting can be located inside the units or externally under the bottom shelf to add the finishing touch to storage units.







I ripiani portabicchieri e portabottiglie rivestiti in cuoio sono una delle numerose opzioni disponibili per personalizzare il sistema Dedalo con accessori che aggiungono funzionalità e stile.

Leather-lined wine glass and bottle racks are just one of the numerous available options for customizing the Dedalo system with accessories that add function and style.



Il ripiano in light stone, moderno e resistente, è l'ideale per ambienti di design contemporaneo, mentre lo scrittoio, con una leggera svasatura nella parte inferiore, conferisce un tocco di raffinatezza e artigianalità.

Modern and strong, the light stone shelf is ideal for interiors with a contemporary design aesthetic, while the desk with the slightly tapered underside brings a touch of refinement and craftsmanship.



DEDALO SYSTEM



Ambienti casa

Home spaces

Fissato a soffitto, Dedalo può essere configurato come libreria divisoria per organizzare gli open space mantenendo gli ambienti aperti e luminosi, grazie a ripiani in vetro e moduli finiti su entrambi i lati che offrono la possibilità di progettare composizioni bifacciali.

When ceiling mounted, Dedalo can be configured as a room-dividing bookcase to organize an open-plan layout, keeping rooms open and light filled with a combination of glass shelves and modules finished on both sides, allowing you to design double-sided configurations.



DEDALO
Sistema / System
—
vetro fumè /
smoked glass
brunito / bronze

STAVE
Armadio / Wardrobe
—
corda
lignum

REA
Tavolo / Table
—
rovere chiaro
light stone
calacatta grey

ELLEN
Sedie / Chairs
—
rovere chiaro
Mya 40





AVENUE
Divano / Sofa
—
Bonnie 01

HAMPTONS
Poltrone /
Armchairs
—
rovere chiaro
Bonnie 01

SHADOWS
Tavolini /
Occasional tables
—
rovere chiaro

GLOBE
Tavolino /
Occasional table
—
cotto

BALANCE
Tavolini /
Occasional tables
—
mogano
cotto

DUO
Mensole / Shelves
—
corda

BOISERIE
Wall panelling
—
rovere chiaro
argilla pomice /
pomice clay

BOX 18
Contenitori /
Storage units
—
argilla pomice /
pomice clay
rovere chiaro

PANCA
Bench
—
argilla pomice /
pomice clay



DEDALO
Sistema / System
—
noce canaletto
bronzo / light bronze
vetro / glass stop-sol
cuoio / leather
testa di moro
light stone breccia
medicea

BLOSSOM
Divano e poltrone /
Sofa and armchairs
—
Dafne 01

FLY
Tavolini /
Occasional tables
—
noce canaletto
marmo opaco /
matt marble
bianco Carrara

Nel living, Dedalo diventa una parete attrezzata completa di TV, contenitori con anta in vetro o anta Rays, ripiani con portabottiglie e altri accessori. Un sistema su misura che arreda anche gli ambienti più classici con leggerezza e funzionalità.

In the living area, Dedalo becomes a storage wall complete with TV, storage units with glass or Rays doors, bottle racks and other accessories. A custom-designed system that elevates more classic interior schemes with added functionality and a light feel.







DEDALO
Sistema / System
—
noce biondo
brunito / bronze
vetro fumè /
smoked glass
light stone
calacatta grey
cuoio / leather
scoglio

LOTO
Pouf / Ottoman
—
Nora 42

VELVET
Poltrone / Armchairs
—
Chioè 01

BALANCE
Tavolino /
Occasional table
—
mogano

GLOBE
Tavolino /
Occasional table
—
noce biondo
brunito / bronze



Arricchito con staffa porta TV orientabile, scrittoio, ripiani in legno e contenitori abbinati, il sistema Dedalo con fissaggio al soffitto crea un'atmosfera sofisticata e accogliente anche nel living contemporaneo, senza rinunciare allo stile. L'apertura a ribalta con cavo tensore e cerniera piana assicura un movimento fluido e preciso, garantendo un facile accesso agli spazi contenitivi del sistema Dedalo.

Enhanced with a TV mounting system, writing shelf, wooden shelves and matching storage units, the ceiling-mounted Dedalo system creates a sophisticated and welcoming atmosphere in contemporary living areas, too, without skimping on style. The pull-down door with cable stay and lay-flat hinge ensures smooth and precise opening, providing easy access to the Dedalo system's storage spaces.





Dedalo può diventare anche angolo bar, con ripiani portabottiglie e portabicchieri, e moduli contenitori con ante in vetro. Una soluzione sofisticata per la convivialità.

Dedalo can also serve as a home bar, with bottle and wine glass racks teamed with storage modules behind glass doors. A sophisticated solution for entertaining.





DEDALO
Sistema / System
—
rovere grigio
peltro / pewter
light stone
calacatta grey
cuoio / leather
scoglio

MAC
Divano / Sofa
—
Nora 06

KIN-O
Tavolino /
Occasional table
—
ginepro

SUNNY
Tavolo / Table
—
argilla / clay lapis
brunito / bronze

AGEL
Sedie / Chairs
—
rovere carbone
Sophie 21

DEEP
Specchio / Mirror
—
brunito / bronze

Dedalo definisce il living con un segno grafico deciso, enfatizzato dal fissaggio a parete. I ripiani accessoriati con portabicchieri e portabottiglie valorizzano lo spazio con dettagli che uniscono raffinatezza e quotidianità.

Dedalo defines the living area by giving it a sharp graphic feel, emphasized by the wall mounting. The shelves accessorized with wine glass and bottle racks enhance the space with details that combine refinement and everyday function.





Una parete attrezzata essenziale e funzionale, pensata per ambienti moderni che coniugano libertà progettuale e ricercatezza formale. Le ante telaio in light stone donano profondità tattile e preziosità materica all'intero progetto.

A pared-back and functional storage wall, designed for modern interiors that blend design freedom and stylish form. The framed doors in light stone give the whole design a tactile depth and an opulent materiality.





DEDALO
Sistema / System
—
lunargento
light stone bianco

STAVE
Armadio / Wardrobe
—
rovere chiaro

NAVY TUB
Sedia / Chair
—
rovere chiaro
Aura 17



Dedalo esprime la sua versatilità in ogni ambiente della casa. In ingresso, dà forma a una configurazione progettata per accogliere in modo elegante e funzionale. Guardaroba, scrittoio, cassettiere e ripiani si combinano con sobrietà, organizzando ogni cosa con coerenza e misura.

Dedalo's versatility shines through in every room in the home. In the entrance, it comes together in a configuration designed to greet occupants and visitors with elegance and function. With a low-key combination of wardrobe, desk, drawer units and shelves, everything is organized with cohesion and restraint.





DEDALO
Sistema / System
rovere chiaro
brunito / bronze

NINFEA
Scrivania / Desk
rovere chiaro
sabbia
Nora 17

AGEL
Sedia / Chair
rovere chiaro
cuoio / leather
cognac

LOTO
Pouf / Ottoman
Callas 17

Dedalo, fissato a soffitto o a parete, può diventare anche una pratica cabina armadio con ripiani, cassettiere e accessori per l'organizzazione dei vestiti, come tubi appendiabiti e griglie porta pantaloni estraibili.

Dedalo can also be ceiling or wall mounted to produce a practical walk-in wardrobe with shelves, drawer units and accessories for organizing clothes, like hanging rails and pull-out trouser racks.





DEDALO
Sistema / System
cotto
cuoio / leather
testa di moro
vetro fumè /
smoked glass

LOG
Pouf / Ottomans
Afrodite 11
Mya 11

HAMPTONS
Poltrona / Armchair
rovere carbone
Mimi 18

MIDNIGHT
Letto / Bed
Iris 11



Dedalo si configura come un guardaroba a vista elegante e funzionale. I contenitori con telaio estraibile, affiancati da ripiani in vetro e in cuoio, valorizzano ogni dettaglio con equilibrio e ricercatezza.

Dedalo can be configured to serve as an elegant and functional wardrobe on proud display. The storage units with pull-out frame, paired with glass and leather-lined shelves, elevate every detail with a sense of balance and stylishness.





DEDALO SYSTEM



Info tecniche

Technical data

Modularità montanti struttura e ripiani / Structure upright and shelf module sizes

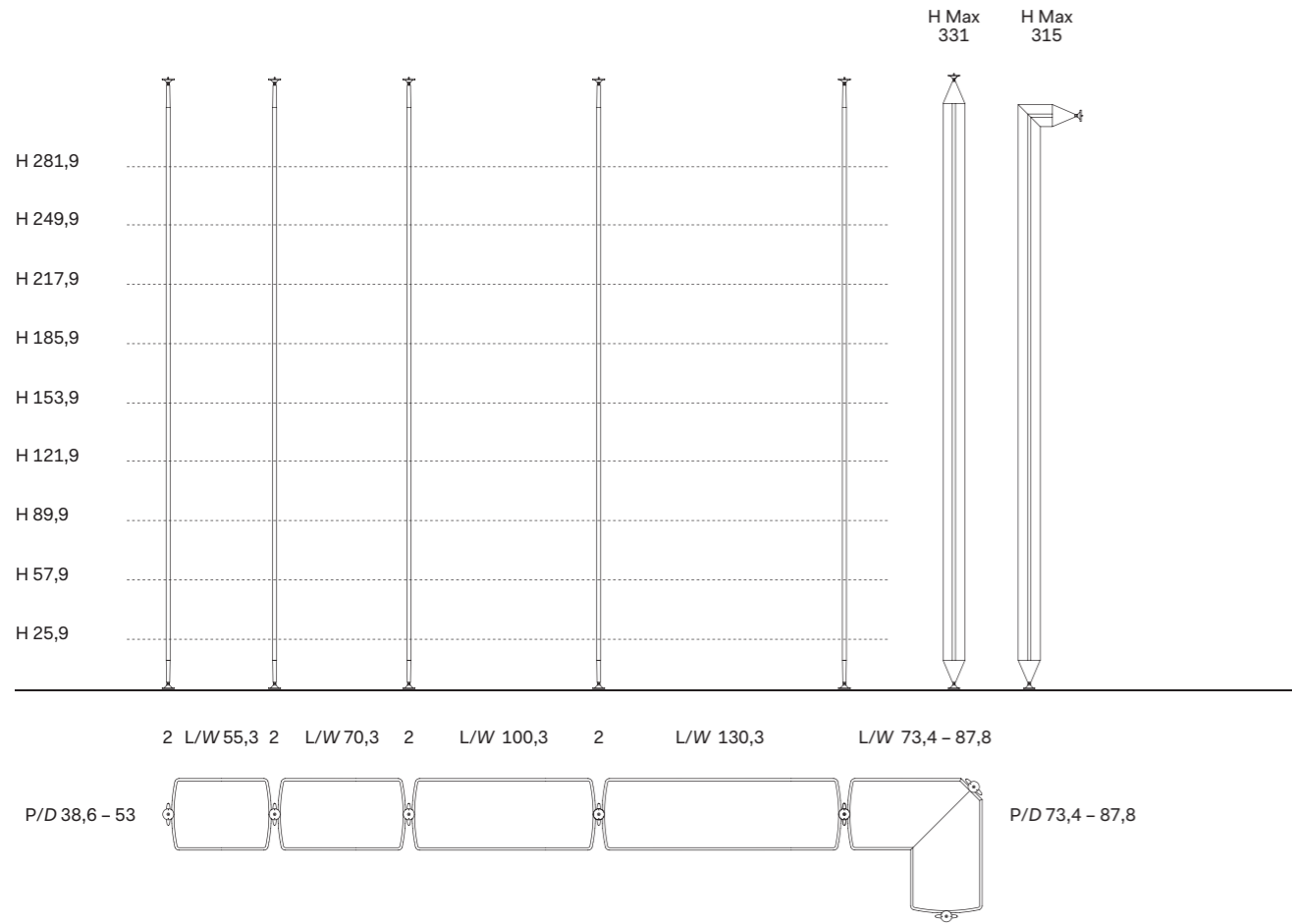

Sistema di fissaggio / Mounting system

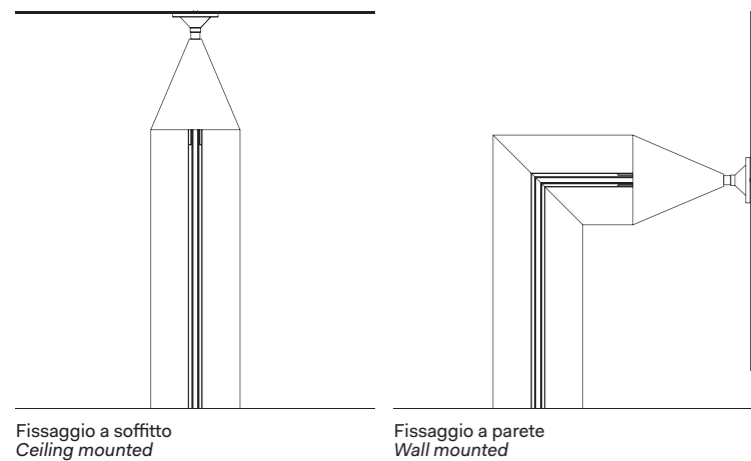

Modularità contenitori / Storage unit module sizes

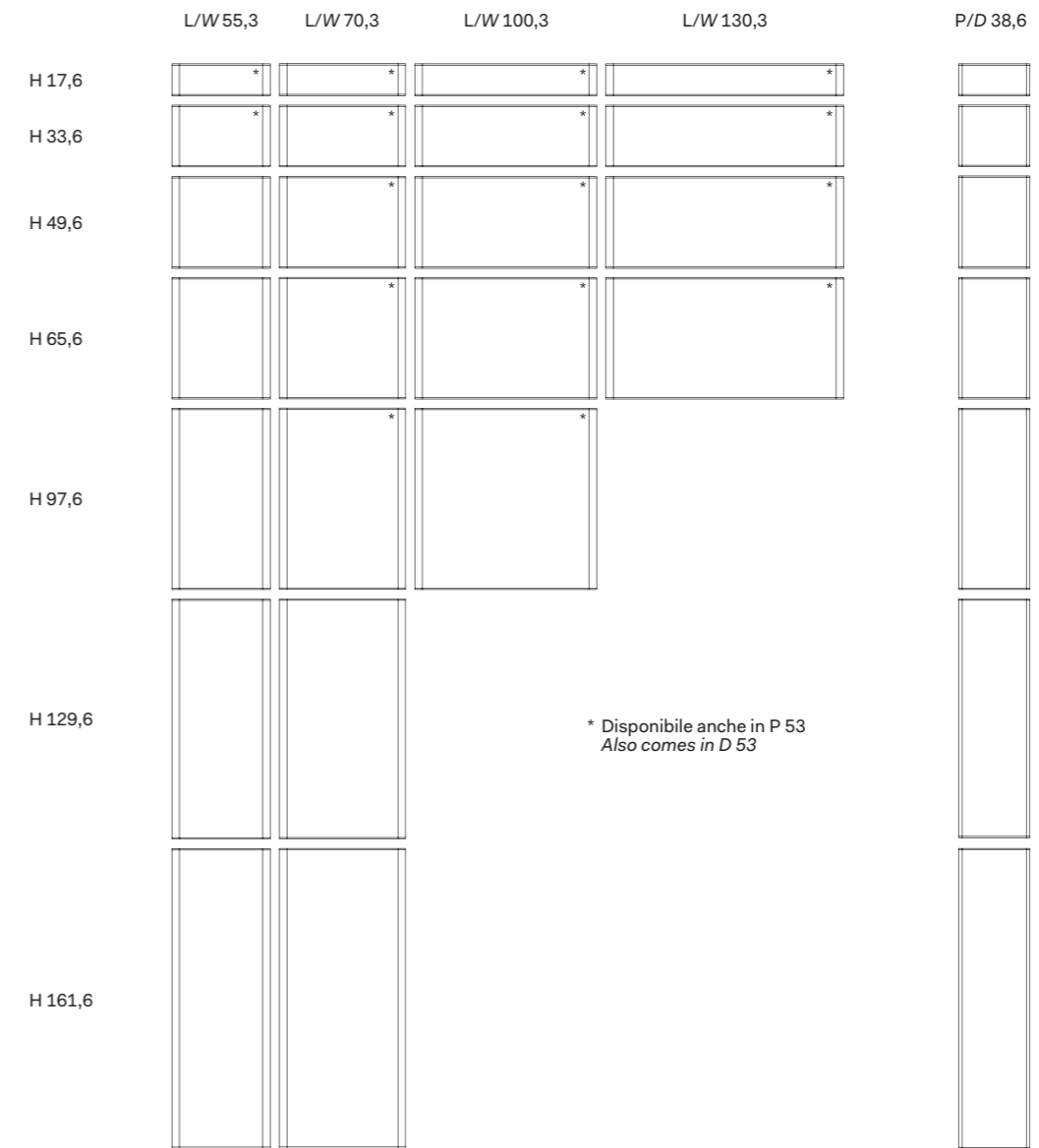

Modularità contenitori con telaio estraibile / Pull-out frame storage unit module sizes

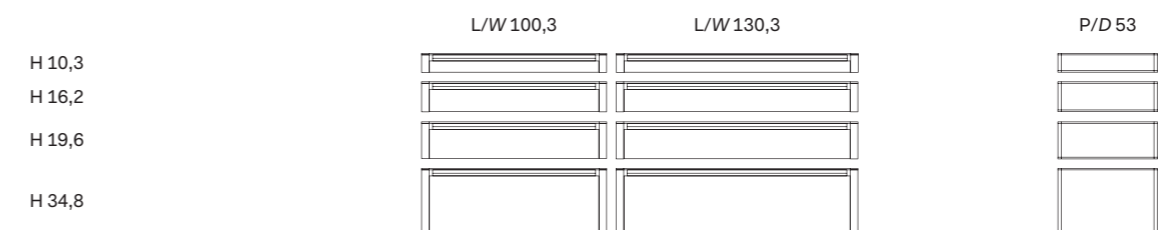

Ante / Doors

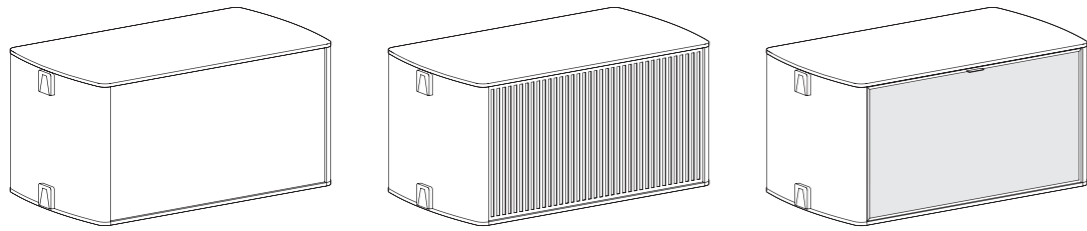

Liscia
Plain

Rays

Telaio per vetro, pannello o light stone
Frame for glass, panel or light stone

Aperture / Opening systems

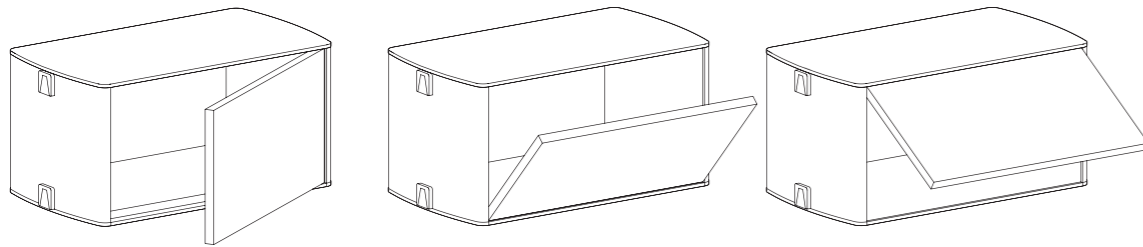

Battente
Hinged

Ribalta
Pull-down door

Rialza
Lift-up door

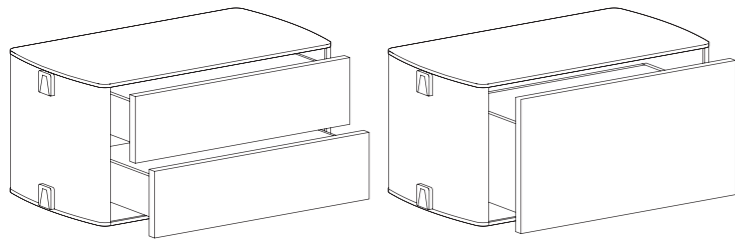

Cassetti
Drawers

Cassettone
Oversized drawer

Illuminazione / Lighting

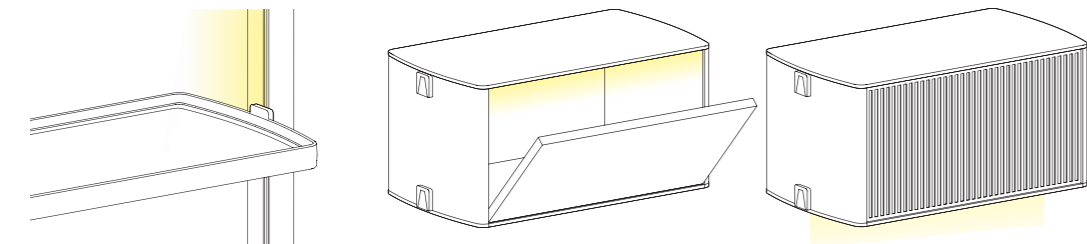

LED su montante, totale o parziale
LED on upright, full height or partial

LED interno su contenitore
Internal LED on storage unit

LED esterno su contenitore
External LED on storage unit

Ripiani / Shelves

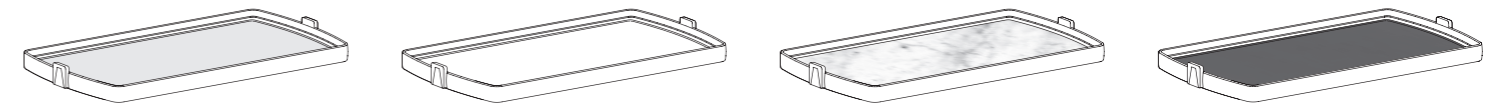

Vetro
Glass

Pannello
Panel

Light stone

Cuoio
Leather

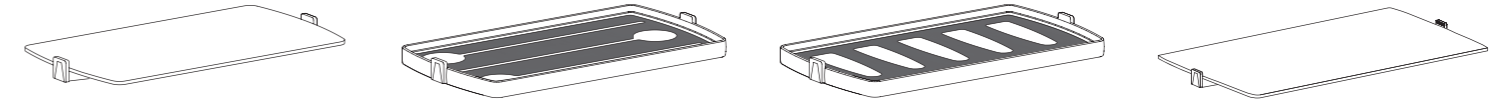

Spessore 0,8 cm
Thickness 0,8 cm

Porta bicchieri
Wine glass rack

Porta bottiglie
Bottle rack

Scrivitoio
Desk

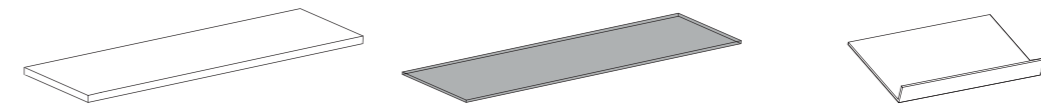

Ripiani per contenitori
Shelves for storage units

Ripiani vetro fumé per contenitori
Smoked glass shelves for storage units

Ripiano interno porta scarpe
Shoe cupboard internal shelf

Componenti ed accessori / Components and accessories

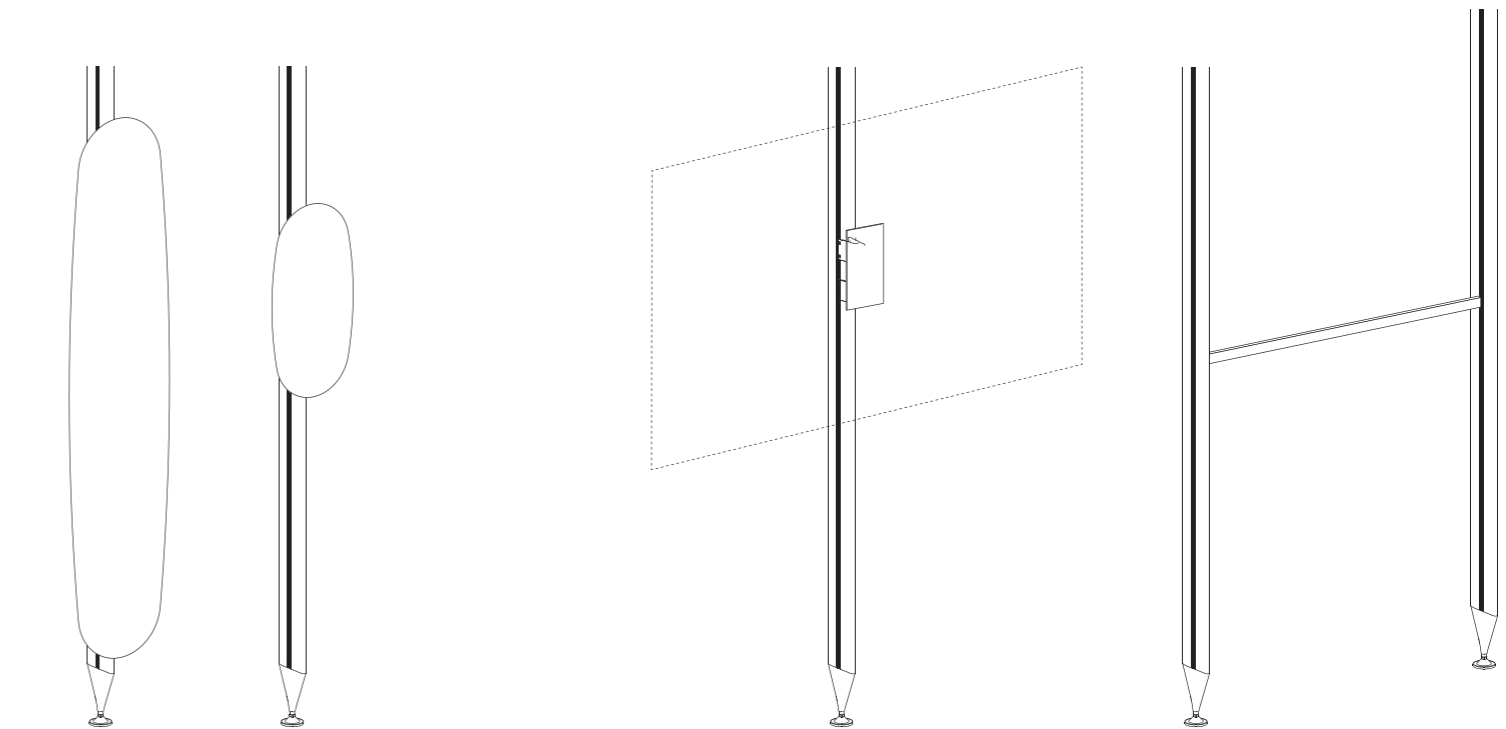

Specchi orientabili
Revolving mirrors

Porta TV con staffa VESA
TV mount with VESA bracket

Tubo appendiabiti
Hanging rail

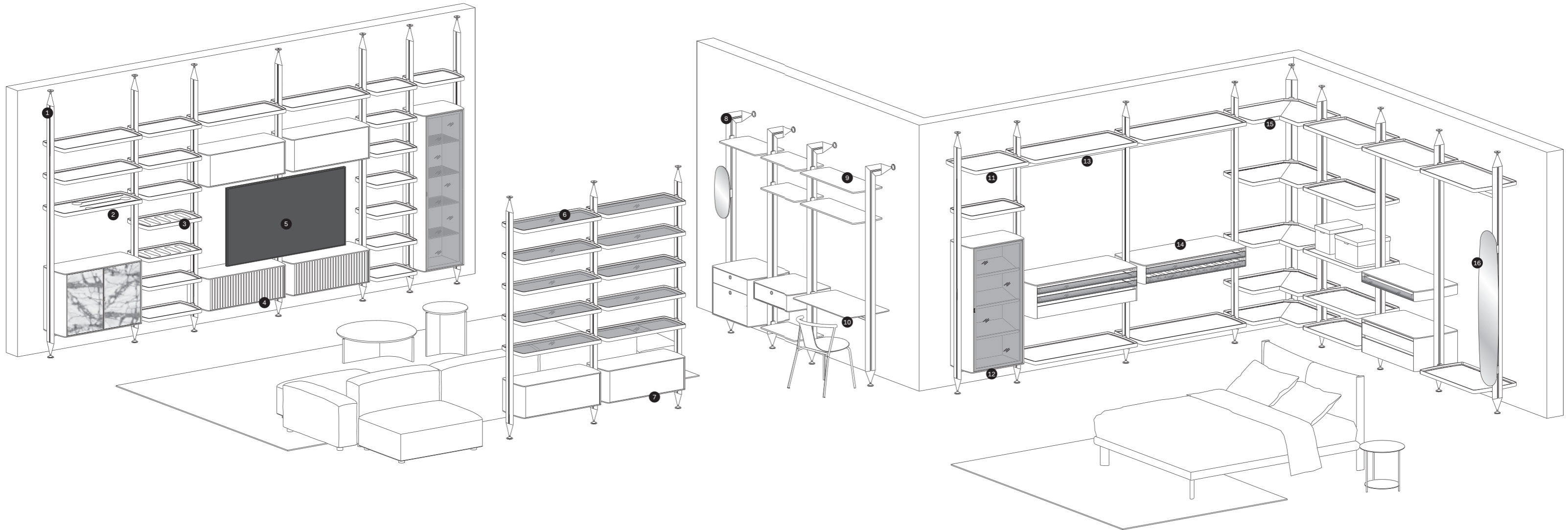

DEDALO SYSTEM

- | | |
|--|--|
| <p>1 Montante terra/cielo
Floor-to-ceiling upright
H Max 331 cm</p> <p>2 Ripiano porta bicchieri
Wine glass rack
P/D 38,6 cm</p> <p>3 Ripiano porta bottiglie
Bottle rack
P/D 38,6 cm</p> <p>4 Contenitore
Storage unit
P/D 38,6/53 cm</p> | <p>5 Porta TV con staffa orientabile VESA
TV mount with VESA swivel bracket</p> <p>6 Ripiano
Shelf
P/D 38,6</p> <p>7 Contenitore retrofinito per centrostanza
Storage unit finished on rear for middle
of room P/D 38,6/53 cm</p> <p>8 Montante a parete
Wall-mounted upright
H Max 315 cm</p> |
|--|--|

- | | |
|---|---|
| <p>9 Ripiano sp. 0,8 cm
Wall-mounted upright
P/D 38,6 cm</p> <p>10 Scrivitoio
Desk
P/D 53 cm</p> <p>11 Ripiano
Shelf
P/D 53 cm</p> <p>12 Contenitore porta scarpe
Shoe cupboard
P/D 38,6 cm</p> | <p>13 Tubo appendiabiti
Hanging rail</p> <p>14 Contenitore con telaio estraibile
Storage unit with pull-out frame
P/D 53 cm</p> <p>15 Ripiano ad angolo
Corner shelf
P/D 38,6/53 cm</p> <p>16 Specchio orientabile
Revolving mirror
H 53,5/160 cm</p> |
|---|---|

Impiallacciato / Veneers



N04
Rovere chiaro



N02
Rovere miele



N01
Rovere terra

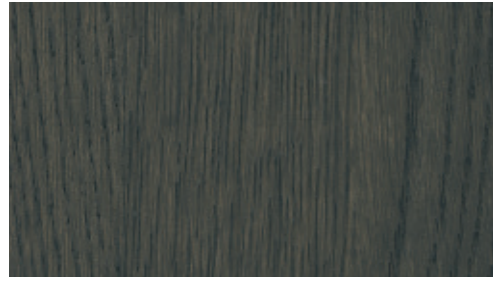

N06
Rovere grigio



N05
Rovere carbone

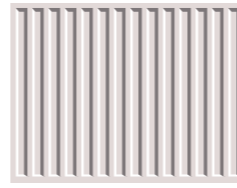

Rays in tutte le finiture
Rays in all finishes

Essenza / Wood finish

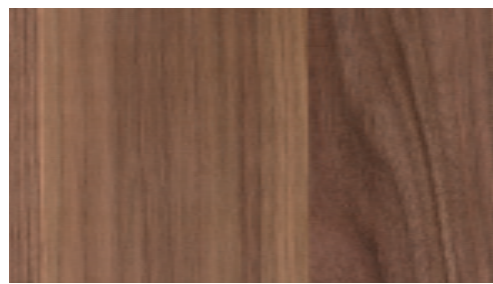

N03
Noce canaletto

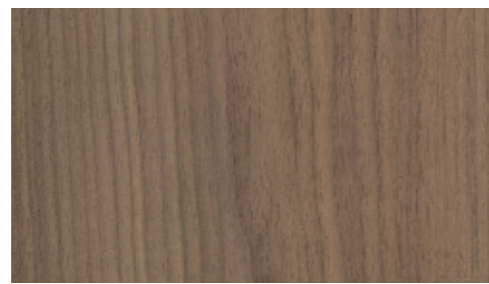

N08
Noce biondo

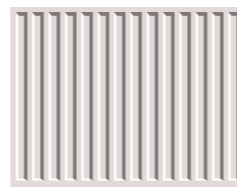

Rays in tutte le finiture
Rays in all finishes

Laccato opaco all'acqua / Water based matt lacquered

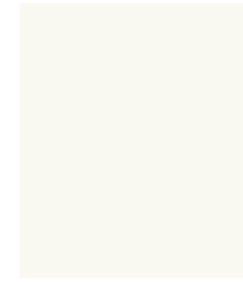

300
Bianco



303
Tortora



333
Sabbia



310
Quarzo



351
Visone



351
Magnolia



318
Nero grafite



341
Cenere



330
Grigio



352
Piombo



353
Blu notte



362
Laguna



355
Ginepro



324
Fango

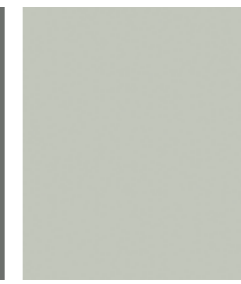

354
Tiglio



342
Foglia



314
Corda



359
Ambra



360
Cotto



361
Mogano



358
Castagna

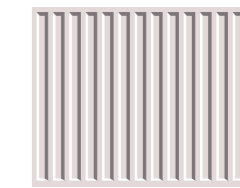

Rays in tutte le finiture
Rays in all finishes

Laccato ossidato / Oxidized lacquered

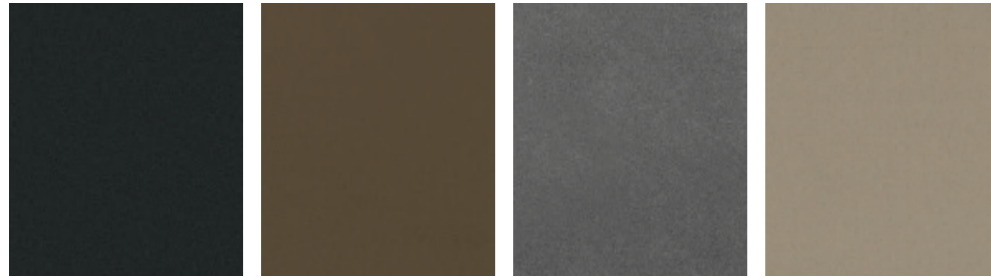

306
Brunite
Bronze

304
Bronzo
Light Bronze

305
Peltro
Pewter

363
Lunargento

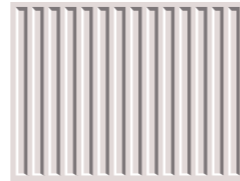

Rays in tutte le finiture
Rays in all finishes

Cuoio / Leather



03W
Cognac

03X
Scoglio

03T
Testa di moro

Laccato metal / Metal lacquered

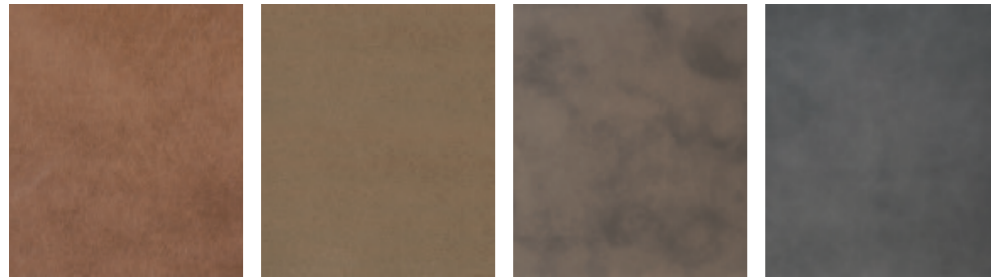

307
Rame
Copper

308
Ottone
Brass

309
Brown

302
Stagno
Tin

Interno scocca / Carcass interior



86
Obsidian

Vetro temperato standard / Standard toughened glass



C80
Fumé
Smoked

Vetro temperato plus / Plus toughened glass



C81
Stop-sol

NOTA
Verificare nelle pagine interne del listino le finiture disponibili per ogni articolo. La resa cromatica dei campioni stampati di finiture e colori è da intendersi indicativa e potrebbe risultare non corrispondente al prodotto commercializzato.

NOTE
Refer to the pages inside the price list to check what finishes are available for each item. Printed samples used to illustrate finishes and colours may not represent the true colour; they are given as a rough guide only and may not match the product actually sold.

Light stone

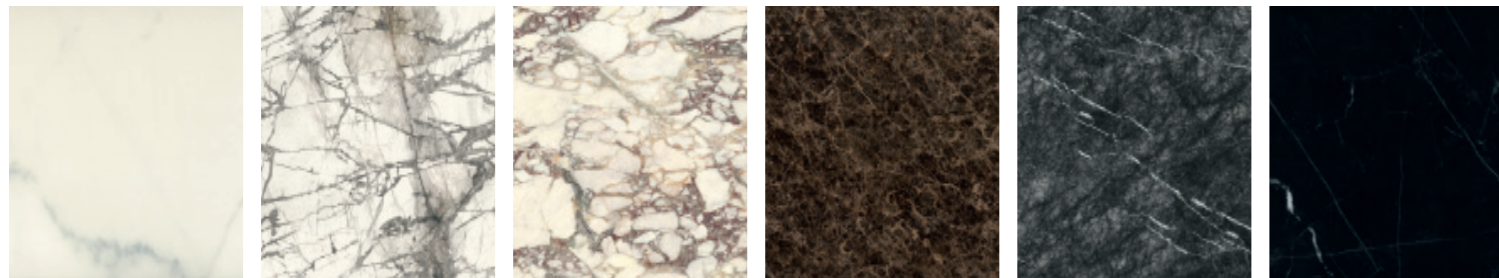

R01
Bianco

R03
Calacatta grey

R05
Breccia medicea

R06
Emperador

R04
Grigio alpi carnia

R02
Nero

Concept
and creative direction
Valeria Carlesso

Art direction
Novamobili studio

Graphic design
Metodo studio

Copywriting
Metodo studio

Concept image
Flavio Favero
Studio Emozioni
Luigina Pilloni

Photography
Studio Emozioni

Styling
Loop Lab:
Luigina Pilloni
Laura Pasqualato

Rendering
Helios Digital

Colour separation
Lucegroup

Printer
Ingrel srl

Printed
Settembre 2025

Thanks to

Andrea house
Artemide
Atelier Manitu
Bigso Box
Bloc Studios
Bloomingville
Broste Copenhagen
Davide Groppi
Design For The
People
ep_clay by Elisa
Pavan
Ferm Living
HKLIVING
Ingrel
La Redoute Intérieurs
Luisa Canovi
Madame Stoltz
New Works
OYOY Living Design
Rosendahl
Society of lifestyle
Studio Emozioni
Super Tuft
VETROelite
Westwing

RIEPILOGO
PRODOTTI

PRODUCTS
SUMMARY

Armadi / Wardrobes:
Stave → p.19, 42

Contentitori / Storage units:
Box18 → p.20

Divani / Sofas:
Avenue → p.20
Blossom → p.22
Mac → p.34

Letti / Beds:
Midnight → p.50

Mensole / Shelves:
Duo → p.20

Poltrone / Armchairs:
Hamptons → p.20, 50
Blossom → p.22
Velvet → p.28

Pouf / Ottomans:
Log → p.50
Loto → p.28, 46

Scrittoi / Desks:
Ninfea → p.46

Sedute / Seats:
Agel → p.34, 46
Ellen → p.19
Navy Tub → p.42

Sistema / System:
Dedalo
p.19, 22, 28, 34, 42, 46, 50

Specchi / Mirrors:
Deep → p.34

Tavoli / Tables:
Sunny → p.34
Rea → p.19

Tavolini / Occasional tables:
Balance → p.20, 28
Fly → p.22
Globe → p.20, 28
Kin-O → p.34
Shadows → p.20

Novamobili si riserva in qualsiasi momento la facoltà di apportare tutte le modifiche necessarie al miglioramento funzionale e qualitativo dei propri prodotti. Per ogni aspetto tecnico e dimensionale fare riferimento ai listini aziendali e relativi aggiornamenti. I colori e i materiali riprodotti nelle immagini stampate hanno un valore indicativo. Novamobili declina ogni responsabilità derivante da eventuali inesattezze di stampa e/o da errori sulle caratteristiche dei prodotti forniti.

In line with its policy of improving product function and quality, Novamobili reserves the right to make any necessary changes at any time. For information of a technical and dimensional nature, refer to the company price lists and relevant updates. The colours and materials reproduced in the image sprinted herein are given as an approximate guide only. Novamobili does not accept any responsibility for misprints and/or mistakes in describing the characteristics of the products supplied.



The mark of
responsible forestry

Richiedi a info@novamobili.it
se il prodotto a cui sei interessato
è certificato FSC®
Ask info@novamobili.it
if the product you are interested
in is FSC® certified.

NOVAMOBILI

Novamobili Spa
via G.Pascoli 14
31053 Pieve di Soligo
Treviso — Italia
T +39 0438 98 68
novamobili@novamobili.it



Battistella
company





HOME SYSTEM DAILY INSPIRED

novamobili.it